

FEATURES

- ▶ Industrial Standard Quarter Brick Package
- ▶ Wide Input Range 43-101VDC & 66-160VDC
- ▶ Excellent Efficiency up to 92%
- ▶ I/O Isolation 3000VAC with Reinforced Insulation
- ▶ Operating Ambient Temp. Range -40°C to +85°C
- ▶ No Min. Load Requirement
- ▶ Under-voltage, Overload/Voltage/Temp. and Short Circuit Protection
- ▶ Remote On/Off, Output Voltage Trim, Output Sensing
- ▶ Vibration and Shock/Bump Test EN 61373 Approved
- ▶ Cooling, Dry & Damp Heat Test IEC/EN 60068-2-1, 2, 30 Approved
- ▶ Railway EMC Standard EN 50121-3-2 Approved
- ▶ Railway Certified EN 50155 (IEC60571) Approved
- ▶ Fire Protection Test EN 45545-2 Approved
- ▶ UL/cUL/IEC/EN 60950-1 Safety Approval & CE Marking



PRODUCT OVERVIEW

The MINMAX MTQZ50 series is a new generation of high performance, convection-cooled 50W DC-DC converters designed specifically for railway applications. They are available for the popular railway input voltages of either 72(43-101)VDC or 110(66-160)VDC.

The converters conform to railway industry transient standard EN 50155 and complies also with EMC standard EN 50121-3-2.

Advanced circuit topology provides a very high efficiency up to 92% which allows operating temperatures range of -40°C to +85°C. For improved heat dissipation the modules can be supplied with a heatsink. Further product features include high, reinforced insulation, remote On/Off control, under-voltage shutdown as well as overload, over voltage, over temperature and short circuit protection.

Model Selection Guide

Model Number	Input Voltage (Range) VDC	Output Voltage VDC	Output Current		Input Current		Reflected Ripple Current mA(typ.)	Over Voltage Protection VDC	Max. capacitive Load µF	Efficiency (typ.) @Max. Load %
			Max.		@Max. Load	@No Load				
			mA		mA(typ.)	mA(typ.)				
MTQZ50-72S05	72 (43 ~ 101)	5	10000	771	50	35	6.2	17000	90	
MTQZ50-72S12		12	4170	755	45		15	2950	92	
MTQZ50-72S15		15	3330	754	45		18	1900	92	
MTQZ50-72S24		24	2080	762	50		30	740	91	
MTQZ50-110S05	110 (66 ~ 160)	5	10000	505	40	35	6.2	17000	90	
MTQZ50-110S12		12	4170	500	35		15	2950	91	
MTQZ50-110S15		15	3330	494	35		18	1900	92	
MTQZ50-110S24		24	2080	499	40		30	740	91	

Input Specifications

Parameter	Model	Min.	Typ.	Max.	Unit
General	Input Specifications comply to				
Input Surge Voltage (100ms. max)	72V Input Models	-0.7	---	165	VDC
	110V Input Models	-0.7	---	250	
Start-up Threshold Voltage	72V Input Models	---	---	43	
	110V Input Models	---	---	66	
Under Voltage Shutdown	72V Input Models	---	40	---	
	110V Input Models	---	63	---	
Start-up Time	All Models	---	0.35	---	S
Input Filter	Internal PI Type				

Remote On/Off Control

Parameter	Conditions	Min.	Typ.	Max.	Unit
Converter On		3.5V ~ 12V or Open Circuit			
Converter Off		0V ~ 1.2V or Short Circuit			
Control Input Current (on)	Vctrl = 5.0V	---	0.5	---	mA
Control Input Current (off)	Vctrl = 0V	---	-0.5	---	mA
Control Common	Referenced to Negative Input				
Standby Input Current	Nominal Vin	---	2.5	---	mA

Output Specifications

Parameter	Conditions / Model	Min.	Typ.	Max.	Unit	
Output Voltage Setting Accuracy		---	---	±1.0	%Vnom.	
Line Regulation	Vin=Min. to Max. @ Full Load	---	---	±0.2	%	
Load Regulation	Io=0% to 100%	---	---	±0.3	%	
Minimum Load	No minimum Load Requirement					
Ripple & Noise ₍₃₎	0-20 MHz Bandwidth	24V Output	---	---	150	mV _{P-P}
		Other Output	---	---	100	mV _{P-P}
Transient Recovery Time	25% Load Step Change ⁽²⁾	---	250	---	μsec	
Transient Response Deviation		---	±3	±5	%	
Temperature Coefficient		---	---	±0.02	%/°C	
Trim Up / Down Range (See Page 5)	% of Nominal Output Voltage	---	---	±10	%	
Over Load Protection	Hiccup	---	150	---	%	
Short Circuit Protection	Continuous, Automatic Recovery (Hiccup Mode 0.5Hz typ.)					

General Specifications

Parameter	Conditions	Min.	Typ.	Max.	Unit
I/O Isolation Voltage	Reinforced Insulation, Rated For 60 Seconds	3000	---	---	VACrms
Isolation Voltage Input/Output to case		1500	---	---	VDC
I/O Isolation Resistance	500 VDC	1000	---	---	MΩ
I/O Isolation Capacitance	100kHz, 1V	---	---	3000	pF
Switching Frequency		---	320	---	kHz
MTBF(calculated)	MIL-HDBK-217F@25°C Full Load, Ground Benign	314,900			Hours
Safety Standards	cUL/UL 60950-1, IEC/EN 60950-1, EN 50155, IEC60571				

Environmental Specifications

Parameter	Conditions / Model	Min.	Max.		Unit
			without Heatsink	with Heatsink	
Operating Ambient Temperature Range Nominal Vin, Load 100% Inom. (for Power Derating see relative Derating Curves)	MTQZ50-72S12	-40	72	75	°C
	MTQZ50-72S15, MTQZ50-110S15				
	MTQZ50-72S24				
	MTQZ50-110S12, MTQZ50-110S24				
	MTQZ50-72S05, MTQZ50-110S05				
Thermal Impedance	20LFM Convection without Heatsink	7.5	---		°C/W
	20LFM Convection with Heatsink	6.8	---		
	100LFM Convection without Heatsink	6.1	---		
	100LFM Convection with Heatsink	4.1	---		
	200LFM Convection without Heatsink	5.3	---		
	200LFM Convection with Heatsink	3.3	---		
	400LFM Convection without Heatsink	3.9	---		
	400LFM Convection with Heatsink	2.2	---		
Base-plate Temperature Range		-40	+105		°C
Over Temperature Protection (Base Plate)		---	+110		°C
Storage Temperature Range		-50	+125		°C
Cooling	Compliance to IEC/EN 60068-2-1				
Dry Heat	Compliance to IEC/EN 60068-2-2				
Damp Heat	Compliance to IEC/EN 60068-2-30				
Shock & Vibration Test	Compliance to IEC/EN 61373				
Fire Protection Test	Compliance to EN 45545-2				
Operating Humidity (non condensing)		5	95		% rel. H
Lead Temperature (1.5mm from case for 10Sec.)		---	260		°C

EMC Specifications

Parameter	Standards & Level		Performance
General	Compliance with EN 50121-3-2 Railway Applications		
EMI	Conduction and Radiation	EN 55032/11, FCC part 15	Class A ₍₇₎
EMS	EN 55024		
	ESD	EN 61000-4-2 air ± 8kV, Contact ± 6kV	A
	Radiated immunity	EN 61000-4-3 10V/m	A
	Fast transient ₍₆₎	EN 61000-4-4 ±2kV	A
	Surge ₍₆₎	EN 61000-4-5 ±2kV	A
	Conducted immunity	EN 61000-4-6 10Vrms	A
	PFMF	EN 61000-4-8 100A/m, 1000A/m For 1 Second	A

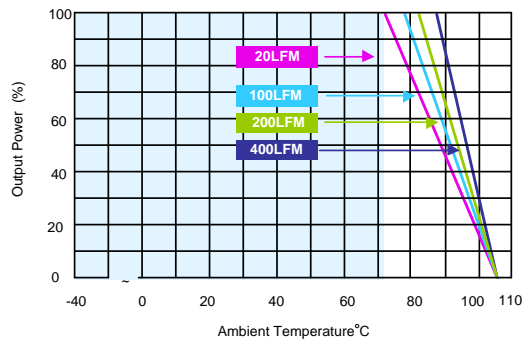
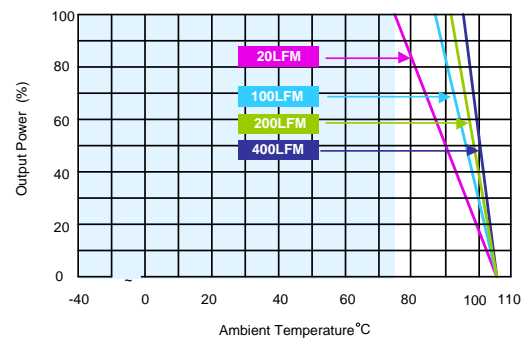
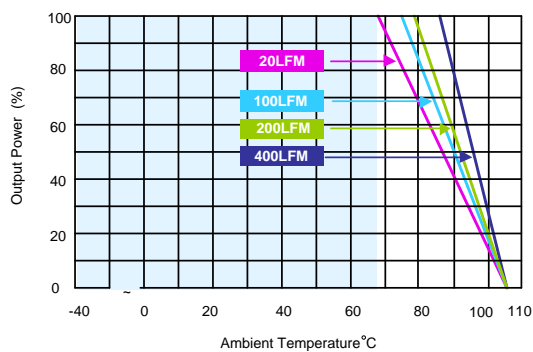
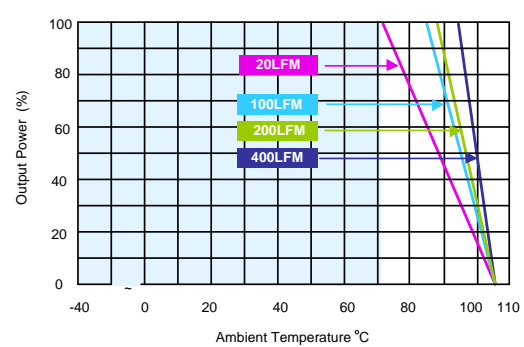
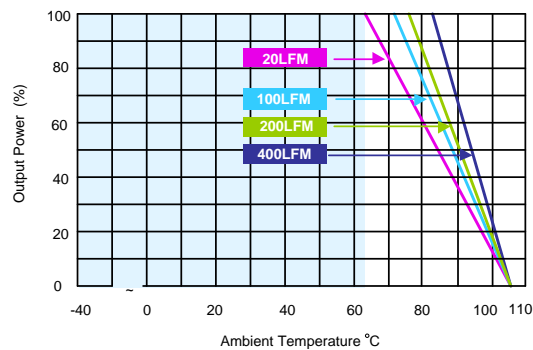
Power Derating Curve

 MTQZ50-72S12,MTQZ50-72S15,MTQZ50-110S15
 Derating Curve without Heatsink

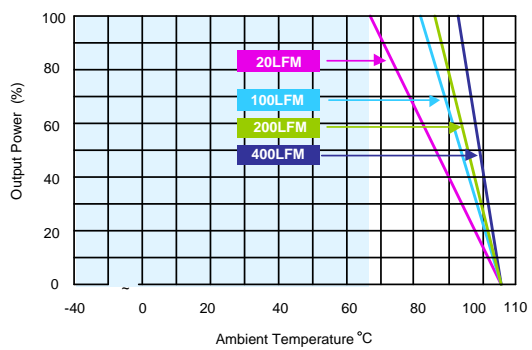
 MTQZ50-72S12,MTQZ50-72S15,MTQZ50-110S15
 Derating Curve with Heatsink

 MTQZ50-72S24,MTQZ50-110S12,MTQZ50-110S24
 Derating Curve without Heatsink

 MTQZ50-72S24,MTQZ50-110S12,MTQZ50-110S24
 Derating Curve with Heatsink

MTQZ50-72S05,MTQZ50-110S05 Derating Curve without Heatsink



MTQZ50-72S05,MTQZ50-110S05 Derating Curve with Heatsink

Notes

- 1 Specifications typical at $T_a=+25^{\circ}\text{C}$, resistive load, nominal input voltage and rated output current unless otherwise noted.
- 2 Transient recovery time is measured to within 1% error band for a step change in output load of 75% to 100%.
- 3 Ripple & Noise measurement with a $1\mu\text{F}$ MLCC and a $10\mu\text{F}$ Tantalum Capacitor.
- 4 Other input and output voltage may be available, please contact factory.
- 5 Part number for heat sink only MT-HS1.
- 6 To meet EN 61000-4-4 & EN 61000-4-5 by adding a capacitor across the input pins. Please contact MINMAX.
- 7 To meet EN 55032 & EN 55011 Class A an external filter, please contact MINMAX.
- 8 It is necessary to parallel a capacitor across the input pins under normal operation. Minimum Capacitance: $68\mu\text{F}/200\text{V}$.
- 9 Specifications are subject to change without notice.

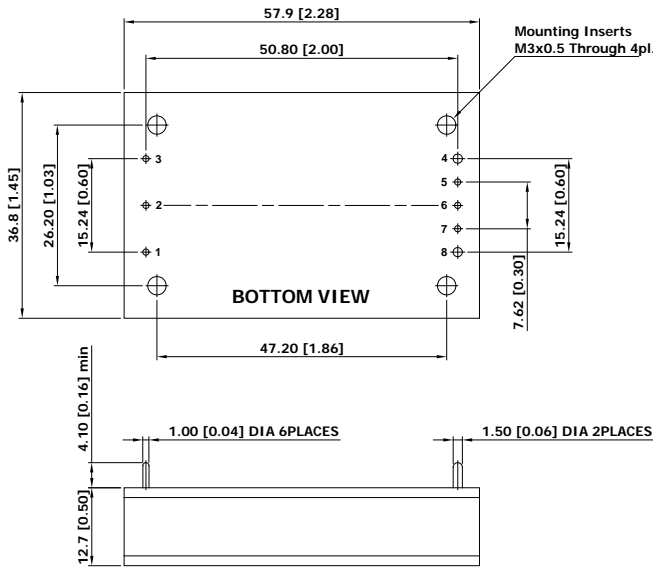
Package Specifications
Mechanical Dimensions

Pin Connections

Pin	Function
1	+Vin
2	Remote On/Off
3	-Vin
4	-Vout
5	* -Sense
6	Trim
7	* +Sense
8	+Vout

* If remote sense not used the +sense should be connected to +output and -sense should be connected to -output
 Maximum output deviation is 10% inclusive of trim

* Please refer to page 6 for pcb installation of power module according to the pictures of standard kit or heatsink kit from end users.

- ▶ All dimensions in mm (inches)
- ▶ Tolerance: X.X±0.5 (X.XX±0.02)
X.XX±0.25 (X.XXX±0.01)
- ▶ Pin diameter \varnothing 1.0 ±0.05 (0.04±0.002)
- ▶ Pin diameter \varnothing 1.5 ±0.05 (0.06±0.002)

Physical Characteristics

Case Size	: 57.9x36.8x12.7 mm (2.28x1.45x0.50 inches)
Case Material	: Aluminum Frame with Black Anodized Coating
Top Side Base Material	: Aluminum Plate
Bottom Side Base Material	: Non-conductive Black Plastic Base Plate
Potting Material	: Epoxy (UL94-V0)
Weight	: 61g

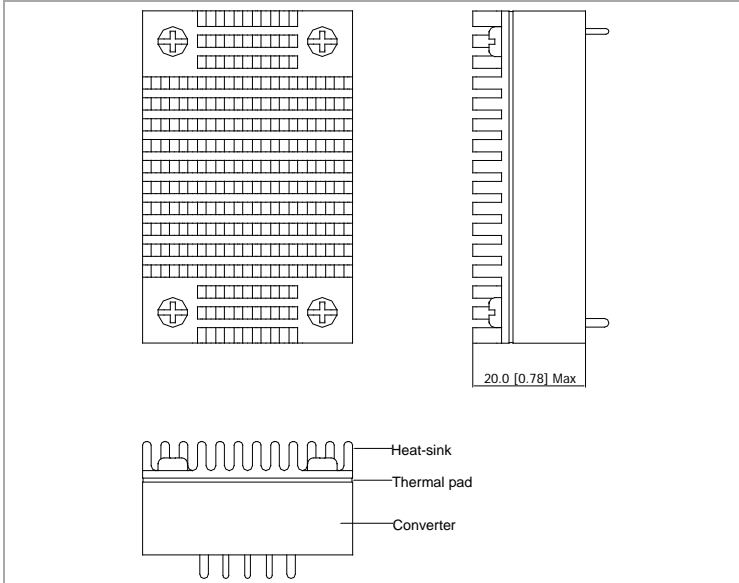
Heatsink (Option -HS)

Physical Characteristics

Heatsink Material	: Aluminum
Finish	: Black Anodized Coating
Weight	: 13g

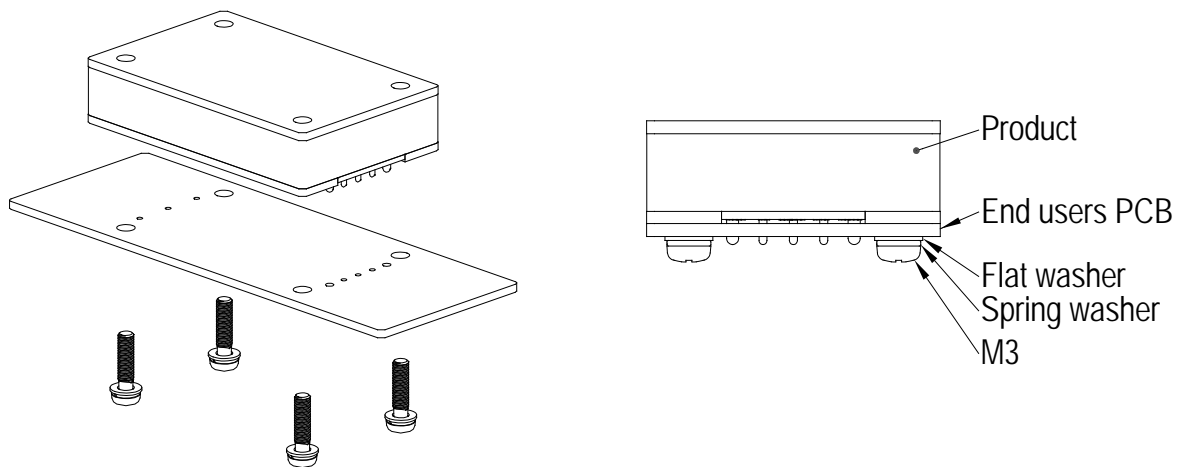
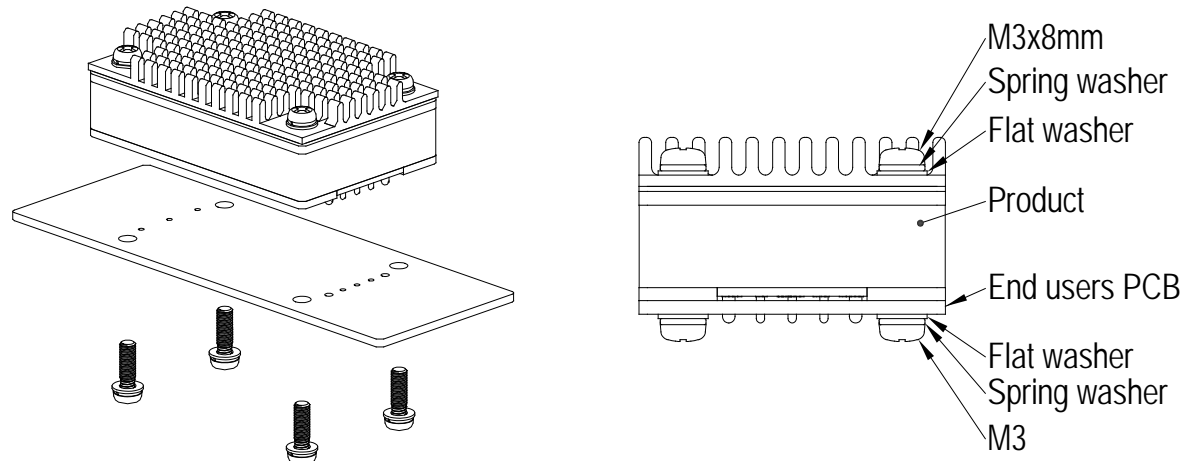
- ▶ The advantages of adding a heatsink are:
1. To improve heat dissipation and increase the stability and reliability of the DC-DC converters at high operating temperatures.
 2. To increase operating temperature of the DC-DC converter, please refer to Derating Curve.

PCB Installation of End Users
Standard Kit

Heatsink Kit

1. Please evaluate mechanical stress (vibration, shock, bump) during field applications.
2. It has to equip with installation kit if excess the guaranteed specifications, please contact MINMAX for detail information.
3. Applied torque per screw 9 kgf.cm min.

External Output Trimming

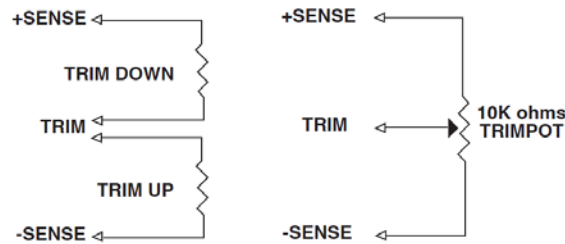
Output can be externally trimmed by using the method shown below



MTQZ50-XXS05 Trim Table

Trim down	1	2	3	4	5	6	7	8	9	10	%
Vout=	Vox0.99	Vox0.98	Vox0.97	Vox0.96	Vox0.95	Vox0.94	Vox0.93	Vox0.92	Vox0.91	Vox0.90	Volts
Rd=	138.88	62.41	36.92	24.18	16.53	11.44	7.79	5.06	2.94	1.24	KOhms
Trim up	1	2	3	4	5	6	7	8	9	10	%
Vout=	Vox1.01	Vox1.02	Vox1.03	Vox1.04	Vox1.05	Vox1.06	Vox1.07	Vox1.08	Vox1.09	Vox1.10	Volts
Ru=	106.87	47.76	28.06	18.21	12.30	8.36	5.55	3.44	1.79	0.48	KOhms

MTQZ50-XXS12 Trim Table

Trim down	1	2	3	4	5	6	7	8	9	10	%
Vout=	Vox0.99	Vox0.98	Vox0.97	Vox0.96	Vox0.95	Vox0.94	Vox0.93	Vox0.92	Vox0.91	Vox0.90	Volts
Rd=	413.55	184.55	108.22	70.05	47.15	31.88	20.98	12.80	6.44	1.35	KOhms
Trim up	1	2	3	4	5	6	7	8	9	10	%
Vout=	Vox1.01	Vox1.02	Vox1.03	Vox1.04	Vox1.05	Vox1.06	Vox1.07	Vox1.08	Vox1.09	Vox1.10	Volts
Ru=	351.00	157.50	93.00	60.75	41.40	28.50	19.29	12.37	7.00	2.70	KOhms

MTQZ50-XXS15 Trim Table

Trim down	1	2	3	4	5	6	7	8	9	10	%
Vout=	Vox0.99	Vox0.98	Vox0.97	Vox0.96	Vox0.95	Vox0.94	Vox0.93	Vox0.92	Vox0.91	Vox0.90	Volts
Rd=	530.73	238.61	141.24	92.56	63.35	43.87	29.96	19.53	11.41	4.92	KOhms
Trim up	1	2	3	4	5	6	7	8	9	10	%
Vout=	Vox1.01	Vox1.02	Vox1.03	Vox1.04	Vox1.05	Vox1.06	Vox1.07	Vox1.08	Vox1.09	Vox1.10	Volts
Ru=	422.77	189.89	112.26	73.44	50.15	34.63	23.54	15.22	8.75	3.58	KOhms

MTQZ50-XXS024 Trim Table

Trim down	1	2	3	4	5	6	7	8	9	10	%
Vout=	Vox0.99	Vox0.98	Vox0.97	Vox0.96	Vox0.95	Vox0.94	Vox0.93	Vox0.92	Vox0.91	Vox0.90	Volts
Rd=	598.66	267.78	157.49	102.34	69.25	47.19	31.44	19.62	10.43	3.08	KOhms
Trim up	1	2	3	4	5	6	7	8	9	10	%
Vout=	Vox1.01	Vox1.02	Vox1.03	Vox1.04	Vox1.05	Vox1.06	Vox1.07	Vox1.08	Vox1.09	Vox1.10	Volts
Ru=	487.14	218.02	128.31	83.46	56.55	38.61	25.79	16.18	8.70	2.72	KOhms

Order Code Table

Standard	With heatsink
MTQZ50-72S05	MTQZ50-72S05-HS
MTQZ50-72S12	MTQZ50-72S12-HS
MTQZ50-72S15	MTQZ50-72S15-HS
MTQZ50-72S24	MTQZ50-72S24-HS
MTQZ50-110S05	MTQZ50-110S05-HS
MTQZ50-110S12	MTQZ50-110S12-HS
MTQZ50-110S15	MTQZ50-110S15-HS
MTQZ50-110S24	MTQZ50-110S24-HS

Test Setup

Input Reflected-Ripple Current Test Setup

Input reflected-ripple current is measured with an inductor L_{in} ($4.7\mu\text{H}$) and C_{in} ($220\mu\text{F}$, $\text{ESR} < 1.0\Omega$ at 100 kHz) to simulate source impedance. Capacitor C_{in} offsets possible battery impedance. Current ripple is measured at the input terminals of the module, measurement bandwidth is $0\text{-}500\text{ kHz}$.

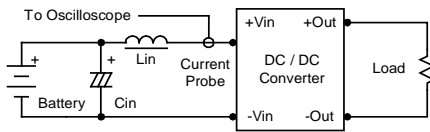

Peak-to-Peak Output Noise Measurement Test

Use a $1\mu\text{F}$ ceramic capacitor and a $10\mu\text{F}$ tantalum capacitor. Scope measurement should be made by using a BNC socket, measurement bandwidth is $0\text{-}20\text{ MHz}$. Position the load between 50 mm and 75 mm from the DC-DC Converter.

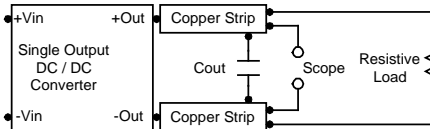

Technical Notes

Remote On/Off

Positive logic remote on/off turns the module on during a logic high voltage on the remote on/off pin, and off during a logic low. To turn the power module on and off, the user must supply a switch to control the voltage between the on/off terminal and the $-V_{in}$ terminal. The switch can be an open collector or equivalent. A logic low is 0V to 1.2V . A logic high is 3.5V to 12V . The maximum sink current at the on/off terminal (Pin 2) during a logic low is $-500\mu\text{A}$.

Overload Protection

To provide hiccup mode protection in a fault (output overload) condition, the unit is equipped with internal current limiting circuitry and can endure overload for an unlimited duration.

Overvoltage Protection

The output overvoltage clamp consists of control circuitry, which is independent of the primary regulation loop, that monitors the voltage on the output terminals. The control loop of the clamp has a higher voltage set point than the primary loop. This provides a redundant voltage control that reduces the risk of output overvoltage. The OVP level can be found in the output data.

Output Ripple Reduction

A good quality low ESR capacitor placed as close as practicable across the load will give the best ripple and noise performance. To reduce output ripple, it is recommended to use $4.7\mu\text{F}$ capacitors at the output.

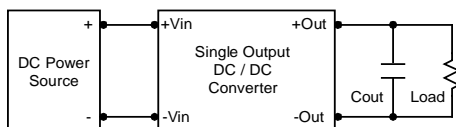

Maximum Capacitive Load

The MTQZ50 series has limitation of maximum connected capacitance at the output. The power module may be operated in current limiting mode during start-up, affecting the ramp-up and the startup time. The maximum capacitance can be found in the data sheet.

Thermal Considerations

Many conditions affect the thermal performance of the power module, such as orientation, airflow over the module and board spacing. To avoid exceeding the maximum temperature rating of the components inside the power module, the case temperature must be kept below 105°C . The derating curves are determined from measurements obtained in a test setup.

